

DESIGN and CONSTRUCTION

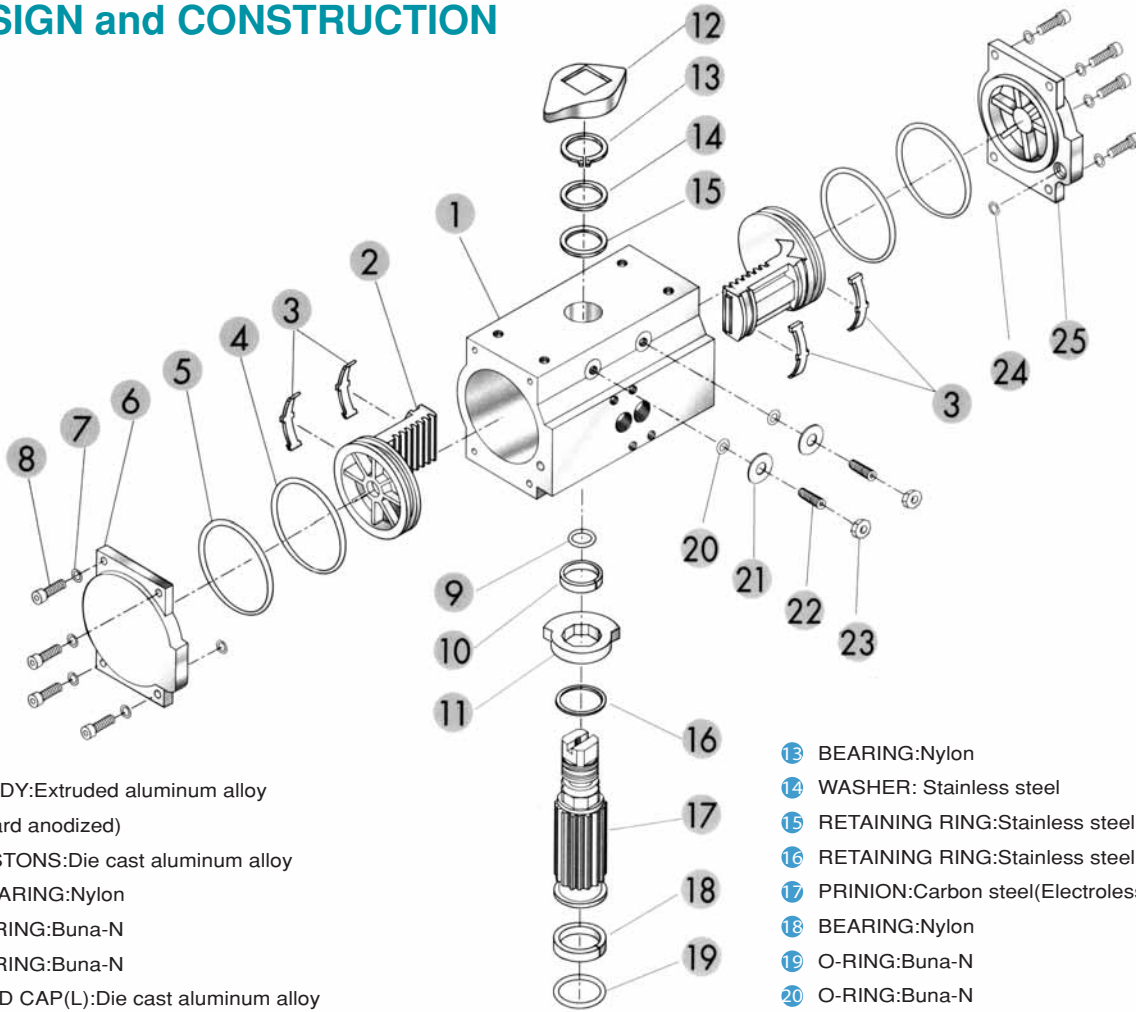

- 1 BODY: Extruded aluminum alloy
- 2 (Hard anodized)
- 3 PISTONS: Die cast aluminum alloy
- 4 BEARING: Nylon
- 5 O-RING: Buna-N
- 6 O-RING: Buna-N
- 7 END CAP(L): Die cast aluminum alloy
- 8 WASHER: Stainless steel
- 9 CAP SCREW: Stainless steel
- 10 O-RING: Buna-N BEARING: Nylon
- 11 STOP CAM: Sinteral steel
- 12 PISTON INDICATOR: Polyethylene

- 13 BEARING: Nylon
- 14 WASHER: Stainless steel
- 15 RETAINING RING: Stainless steel
- 16 RETAINING RING: Stainless steel
- 17 PRINION: Carbon steel (Electroless nickel plated)
- 18 BEARING: Nylon
- 19 O-RING: Buna-N
- 20 O-RING: Buna-N
- 21 WASHER: Stainless steel
- 22 STOP SCREW: Stainless steel
- 23 NUT: Stainless steel
- 24 O-RING: Buna-N
- 25 END CAP(R): Die cast aluminum alloy

Bi-Directional Travel Stop Illustration

MODENTIC-Series actuators feature bi-directional pinion travel stops. Side located stops allow a full ± 5 of valve travel adjustment, giving a guaranteed range of adjustment between 80 and 100 of actuator travel. These travel stops are designed to absorb the maximum impact loads associated with recommended stroke speed.

Standard Assembly

Adjustment of the counterclockwise and clockwise rotation limits are accomplished by turning the respective left and right stop adjustment screws to reduce or increase output rotation.

Travel Adjustment Range

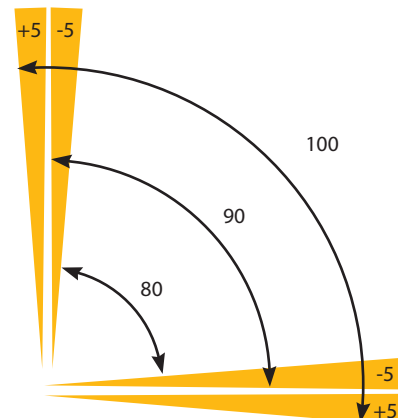



Actuator Technical Features

PERFORMANCE

- Operating Pressure Range: 40 to 120 PSIG.
- Maximum Allowable Working Pressure: 150PSIG.
- Maximum Operating Pressure: 120PSIG.
- Operating Media: Dry or lubricated non-corrosive gas.
- Operating Temperature Standard: -40F to +200F

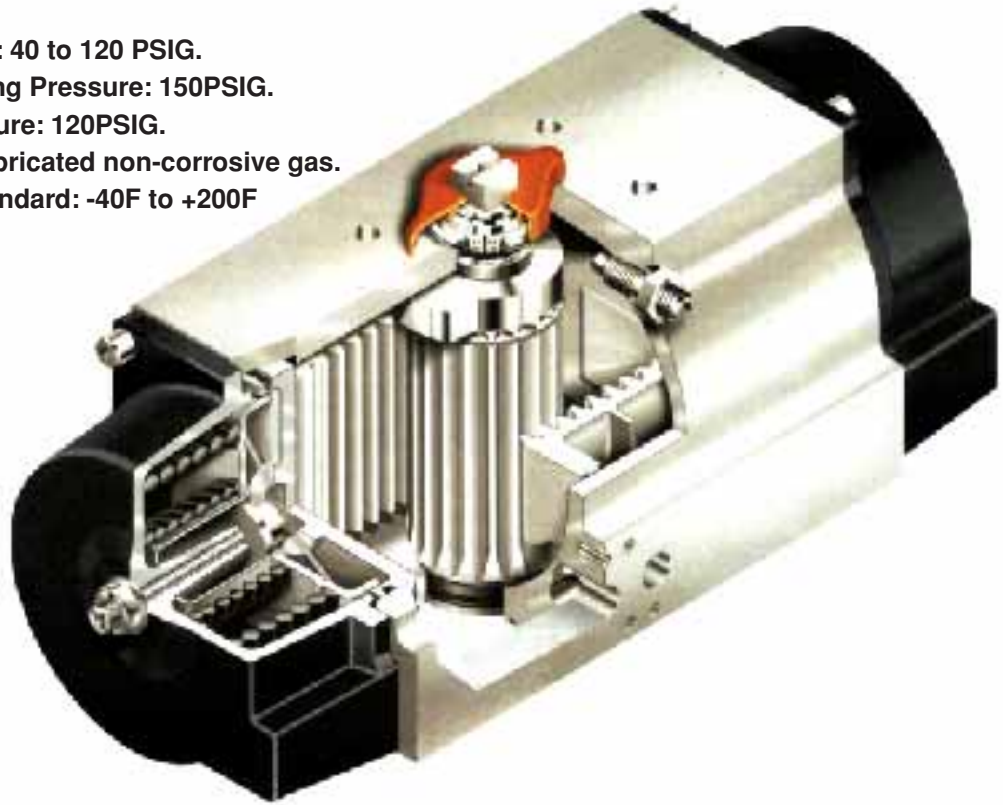

Operation

Double-Acting(Top View)

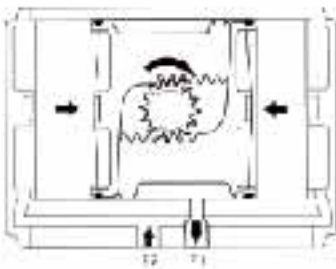

For clockwise output, apply pressure to P2, which force the pistons to move together. The volume between the pistons is exhausted at P1

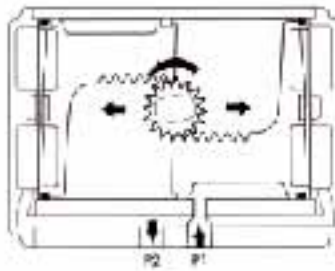

For counterclockwise output, apply pressure to P1, which force the pistons apart. The linear travel of the pistons is converted to a rotation of the drive shaft by the rack to pinion connection. The volume outside each piston is exhausted at P2.

*When required Reverse Rotation the pistons can be inverted in the housing resulting in a clockwise rotation when pressure is applied to P1.

Spring-Return(Top View)

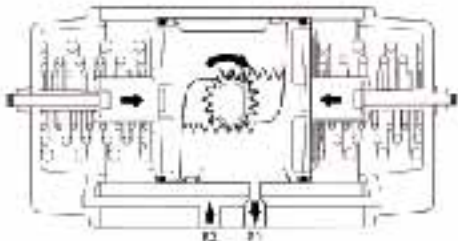

For clockwise output, the volume between the pistons is exhausted at P1, causing the springs to force the pistons together. The volume outside the pistons is vented at P2.

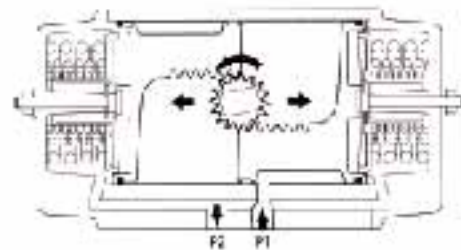

For counterclockwise output, apply pressure to P1, which force the pistons apart and compress the springs. The linear travel of the pistons is converted to a rotation of the drive shaft by the rack to pinion connection. The volume outside each piston is exhausted at P2.

*When required, Reverse Rotation the pistons can be inverted in the housing resulting in a clockwise rotation when pressure is applied to P1 and a counterclockwise rotation when P1 is vented.

DIMENSIONS

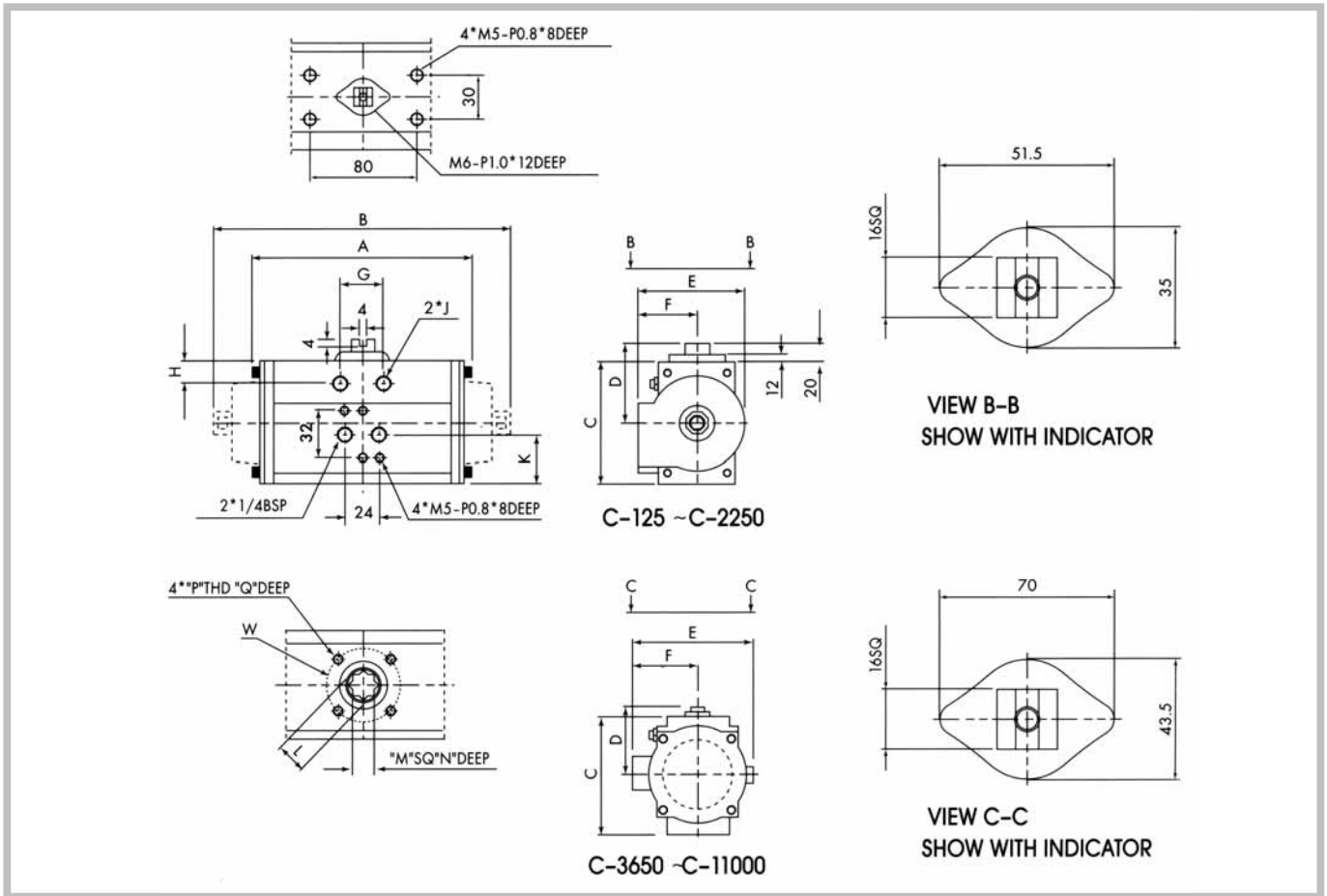

(UNIT:MM)

Model	ISO PATTERN	OUTPUT TORQUE AT 80PSI AIR	A	B	C	D	E	G	H	J
C-125	F04	125IN-LB	120.0	--	64.0	52.2	62.2	24.0	11.0	MxP0.8
C-250	F04 or F05	250IN-LB	144.3	194.6	79.0	57.7	81.4	32.5	12.6	M5xP0.8
C-450	F05 & F07	450IN-LB	149.2	205.6	98.0	67.4	95.0	32.5	13.8	M6xP1.0
C1000	F05 & F07	1000IN-LB	183.0	250.0	121.0	79.2	119.0	46.2	16.6	M8xP1.25
C-2250	F07 & F10	2250IN-LB	259.6	355.0	141.0	89.5	140.5	54.0	18.6	M10xP1.5
C-3650	F10 & F12	3650IN-LB	304.3	422.0	176.0	99.1	185.2	79.7	27.3	M12xP1.75
C-5000	F10 & F12	5000IN-LB	364.4	487.0	196.0	116.5	204.8	79.4	28.3	M12xP1.75
C-11000	F14	11000IN-LB	490.0	642.0	243.7	138.5	238.2	95.3	35.8	M16xP2.0

Model	ISO PATTERN	OUTPUT TORQUE AT 80PSI AIR	K	L	M	N	P	Q	W
C-125	F04	125IN-LB	23.5	12.5	9.0	10.0	M5xP0.8	8.0	11.0
C-250	F04 or F05	250IN-LB	29.7	14.5	11.0	17.0	M5xP0.8/M6xP1.0	8.0/10.0	12.6
C-450	F05 & F07	450IN-LB	30.2	18.8	14.0	21.0	M6xP1.0/M8xP1.25	10.0/12.0	13.8
C1000	F05 & F07	1000IN-LB	33.5	23.0	17.0	25.5	M6xP1.0/M8xP1.25	10.0/12.0	16.6
C-2250	F07 & F10	2250IN-LB	39.0	29.5	22.0	31.0	M8xP1.25/M10xP1.5	12.0/15.0	18.6
C-3650	F10 & F12	3650IN-LB	97.4	35.5	27.0	35.5	M10xP1.5/M12xP1.75	15.0/19.0	27.3
C-5000	F10 & F12	5000IN-LB	99.0	35.5	27.0	35.5	M10xP1.5/M12xP1.75	15.0/19.0	28.3
C-11000	F14	11000IN-LB	124.7	47.5	36.0	45.0	M16xP2.0	140.0	35.8



Actuator Technical Features

Pneumatic Rack & Pinion Actuators TORQUE RATINGS (IN-LBS) Double-Acting Actuators

Model	Air Torque Output at Operating Pressure-Psig				
	40	60	80	100	120
C-125	63	94	125	156	188
C-250	125	187	250	312	375
C-450	225	337	450	562	675
C1000	500	750	1000	1250	1500
C-2250	1125	1687	2250	2812	3375
C-3650	1825	2738	3650	4563	5475
C-5000	2500	3750	5000	6250	7500
C-11000	5500	8250	11000	13750	16500

Spring-Return Actuators

Model Number		Spring Torque Output		Air Torque Output at Operating Pressure-Psig									
Basic	Spring			40		60		80		100		120	
	Set	Start	End	Start	End	Start	End	Start	End	Start	End	Start	End
C-250	2	69	45	76	47	138	109	201	172	263	234	326	312
	3	104	67			113	70	176	133	229	195	301	258
	4	140	90			88	31	151	93	213	156	276	218
	5	175	112					126	54	189	116	251	179
	6	209	135							164	77	227	139
C-450	2	126	81	135	83	248	196	361	309	473	421	586	533
	3	190	121			203	125	316	238	428	350	541	463
	4	254	162			158	54	271	167	383	279	496	392
	5	317	202					226	96	339	209	451	321
	6	381	243							293	137	406	251
C-1000	2	279	179	300	184	549	433	798	682	1048	931	1297	1181
	3	418	270			449	278	698	526	947	775	1196	1025
	4	559	360			350	120	599	371	848	618	1097	867
	5	698	450					500	212	749	464	998	710
	6	839	540							650	304	899	557
C-2250	2	659	394	690	395	1253	958	1816	1521	2379	2084	2939	2647
	3	990	590			1034	591	1596	1154	2159	1717	2722	2280
	4	1320	787			816	226	1379	788	2029	1351	2505	1914
	5	1650	984					1161	424	1724	984	2287	1549
	6	1980	1181							1506	621	2069	1181
C-3650	2	1053	607	1152	659	2063	1570	2975	2482	3886	3393	4797	4305
	3	1573	912			1726	996	2637	1907	3549	2819	4460	3730
	4	2091	1217			1388	423	2300	1335	3211	2246	4123	3157
	5	2625	1519					1967	744	2878	1655	3789	2566
	6	3144	1824							2540	1082	3452	1994
C-5000	2	1560	785	1590	803	2780	1990	3970	3180	5160	4380	6350	5570
	3	2340	1180			2380	1200	3570	2400	4760	3590	5960	4780
	4	3130	1570			1980	414	3180	1600	4370	2800	5560	3990
	5	3910	1960					2780	815	3970	2010	5160	3200
	6	4690	2360							3570	1220	4760	2410
C-11000	2	3400	1720	3460	1760	6060	4360	8660	6960	11300	9560	13900	12200
	3	5100	2570			5200	2650	7790	5240	10400	7840	13000	10400
	4	6790	3430			4330	932	6930	3530	9520	6130	12100	8730
	5	8490	4290					6060	1810	8660	4410	11300	7010
	6	10200	5150							7790	2700	10400	5300